

THIS COPY IS PROVIDED ON A RESTRICTED BASIS AND IS NOT TO BE USED IN ANY WAY DETRIMENTAL TO THE INTERESTS OF PANDUIT CORP.

Material	High Conductivity Seamless Copper Tube
Plating	Electro-Tin
Wire Size & Type	Stranded Copper Flex Cable; 4/0 AWG (550/24) Diesel Locomotive, 4/0 FLEX K,M Class K & Class M
Wire Strip Length	1-11/16 in.
Stud Size	3/8 in.
UL Listed Wire Connector	Yes, for applications up to 35kv. Consult cable manufacturer for voltage stress relief instructions with applications greater than 2000 volts.
UL Temperature Rating	90° C
C.S.A Certified Wire Connector	Yes
Panduit Color Code on Barrel	YELLOW
Panduit Die Index No. on Barrel	P62
Alternate Industry Die Index No. ( ) on Barrel	(16)

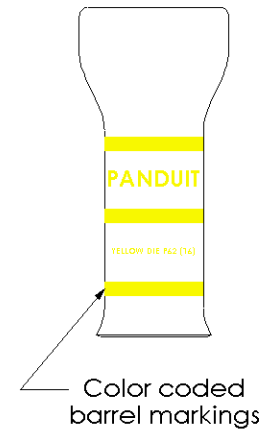
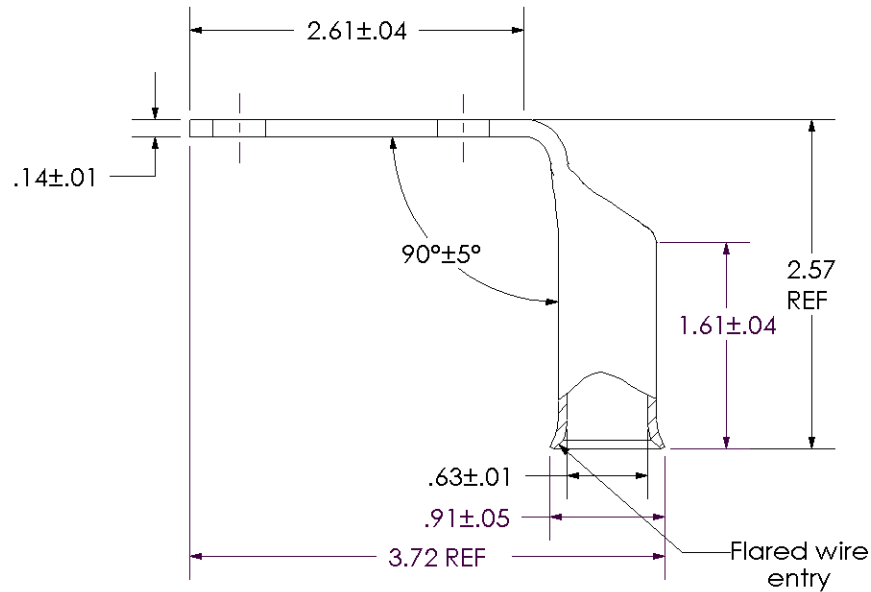
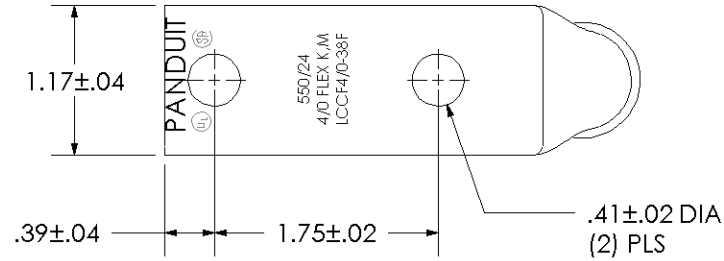

00	9/02	SAB	DRL	RELEASED	10338
REV	DATE	BY	CHK	DESCRIPTION	ECN

**PANDUIT CORP. TINLEY PARK, ILLINOIS**

LCCF4/0-38F-X  
Copper Lug - Two-Hole, Flared Barrel, 90° Angle Tongue

SCALE N/A

DRAWING NO / CAD FILE

LCCF4\_0-38F-CUST